

R.P. SMA (F) B.H. to I-Pex MHF 1.13D 73mm CA/A

P.N. : J41-F1F39-09

Products feature

- Compatible with Hirose U.FL, Sunridge MCB, and CMP series.
- Cable Available with 0.8, 1.13, 1.32 and 1.37Dia.
- Vertical Mounting on receptacle.
- Various application. (Mobile Phone, Smart phone, Navigation, etc)
- Mated Height 2.5mm

Electrical specification

Item	Specification
Frequency range	DC ~ 6.0 GHz
Impedance	50 Ω
V.S.W.R (Max)	1.30 : 1 (3GHz) 1.50 : 1 (6GHz)
Temperature Range	- 40°C ~ 85°C
Voltage Rating	250 Vrms
Contact Resistance	15m ohm Max
Withstanding Voltage	AC300Vrms
Insulation Resistance	500m ohm Min

Material specification

Item	Specification
Outer Contact	Copper Alloy / Gold plated
Center Contact	Copper Alloy / Gold plated

Drawing



Form Factor

- Cable Assembly

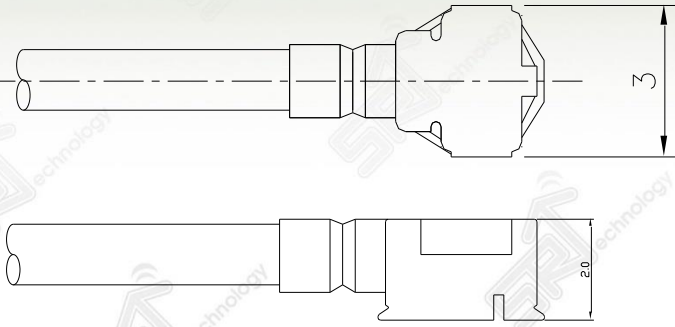

- PCB connector

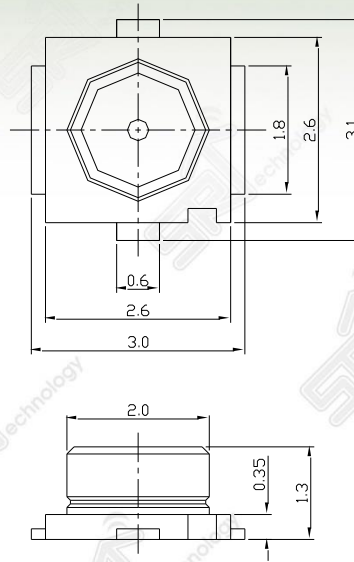

- PCB Layout

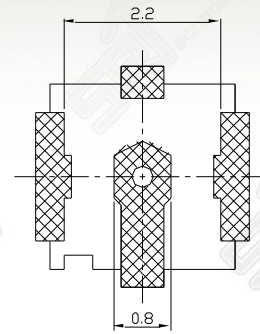

Mating Height

- Before Mating

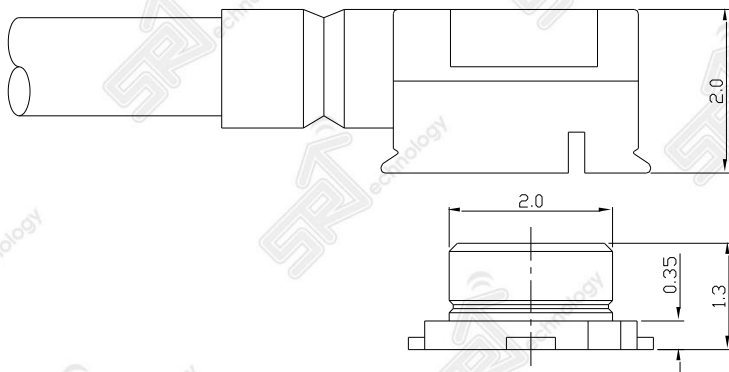

- After Mating

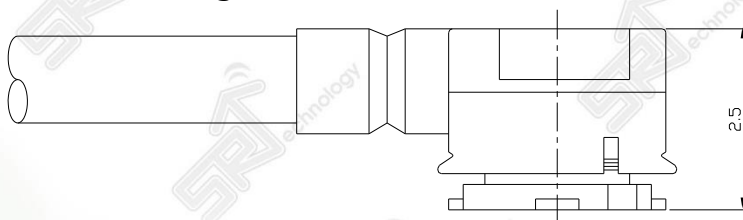

Other Available Connector type

SMA R.A.
JACK 4R
PCB

P.N. : J21-F1F39-01

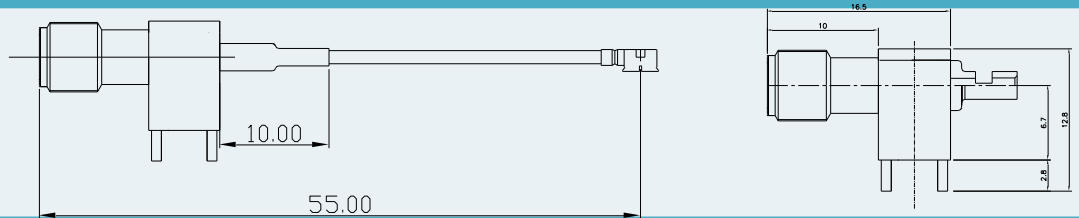

SMA J B.H.

P.N. : J21-F1F39-04

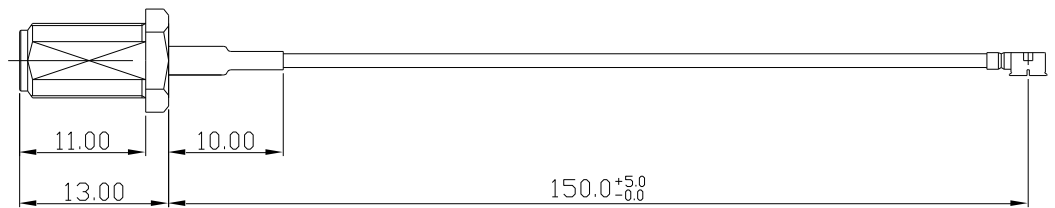

R.P. SMA J
B.H.

P.N. : J41-F1F39-08



SMA P

P.N. : J11-F1F39-01

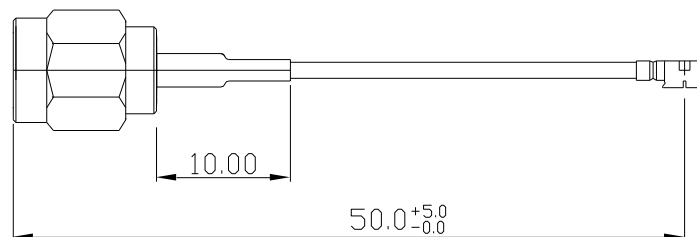

MCX J

P.N. : J21-F6F39-05

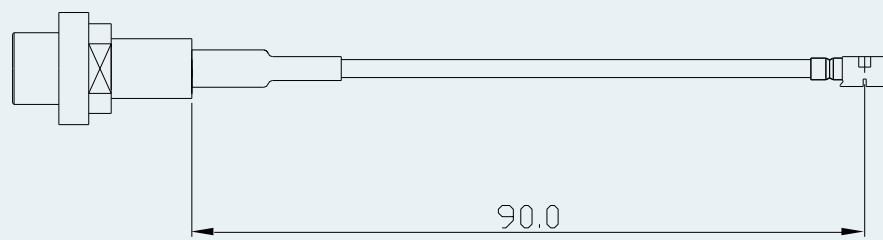

MCX J RA
Pcb

P.N. : J21-F6F39-06

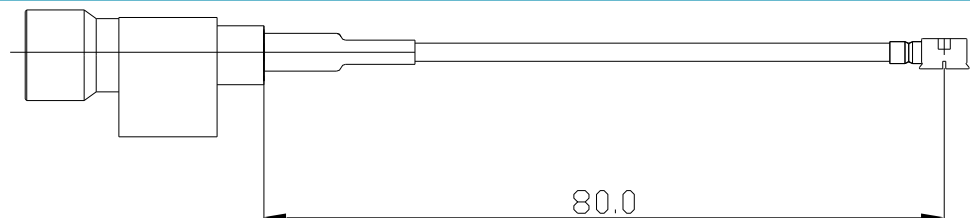

MCX J RA
Pcb

P.N. : J21-F6F39-02

