

N 2Watt 8dB 8GHz Attenuator

P.N. : F04-B0808-02

Products feature

- Reliable V.S.W.R
- Wide broadband frequency application
- Directional 2 Watt rating



Electrical specification

Item	Specification
Frequency range	DC ~ 8.0 GHz
Impedance (Nominal)	50Ω
Power rating	2 watt
Attenuation	8 dB +/- 0.6dB/max
V.S.W.R (Max)	1.20 : 1
Connector type	N male – female

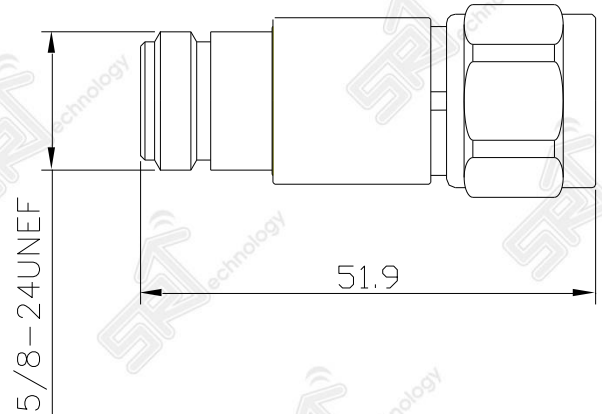

Material specification

Item	Specification
Connector	Brass / Nickel plating
Body	Brass / Nickel plating